

# RUČNA TRANSPORTNA KOLICA

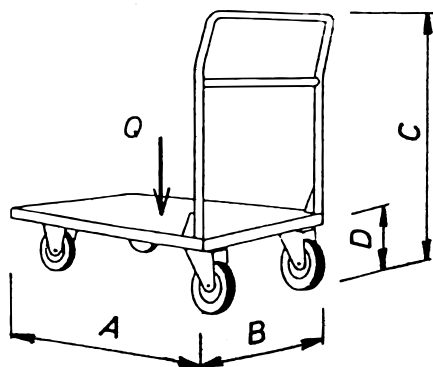
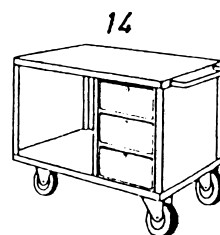
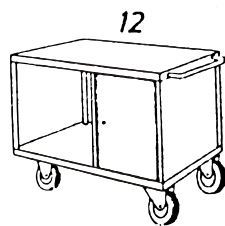
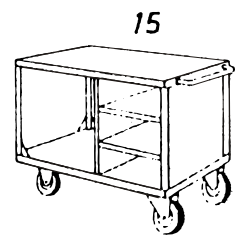
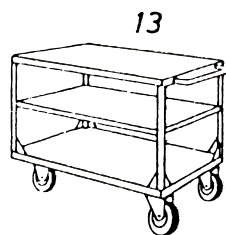
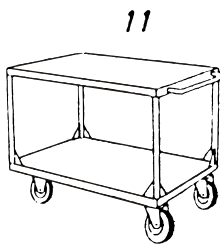
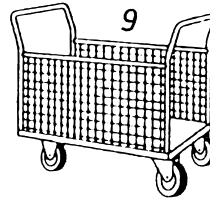
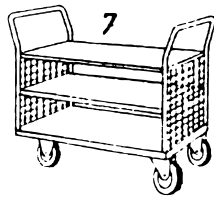
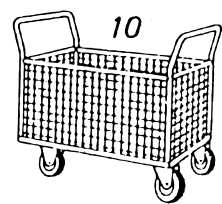
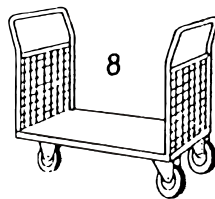
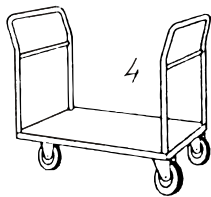
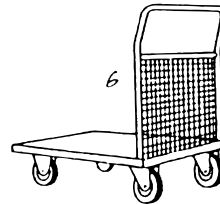
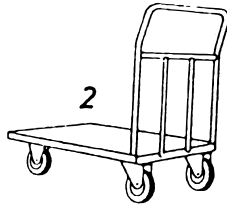
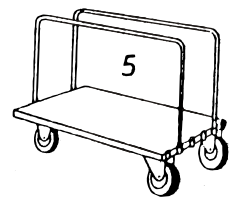
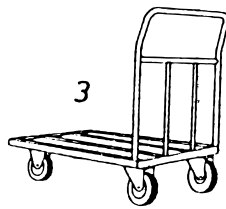
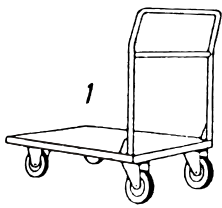

	A <sub>mm</sub>	B <sub>mm</sub>	C <sub>mm</sub>	D <sub>mm</sub>	Q <sub>kN</sub>
K 08-05	800	500	820	167	2.5
K 10-07	1000	700	850	232	5
K 12-08	1200	800	850	232	5
<b>KOLICA PLATFORMA</b>	<b>KOLICA MREŽASTA</b>		<b>KOLICA STOL</b>		
TIP 1	TIP 6		TIP 11		
TIP 2	TIP 7		TIP 12		
TIP 3	TIP 8		TIP 13		
TIP 4	TIP 9		TIP 14		
TIP 5	TIP 10		TIP 15		